







Antonio Citterio con Toan Nguyen

Sedis Sedis Torsion benches

205

Disponibile nei seguenti materiali e dimensioni:
Available in the following materials and sizes:
Disponible dans les dimensions et matériaux suivants:
Disponible en los siguientes materiales y tamaños:
Disponível nos seguintes materiais e tamanhos:
Erhältlich in den folgenden Materialien und Größen:

 Ghisa / Cast / Iron
Fonte / Fundición
Ferro fundido / Gußeisen

 Legno / Wood
Bois / Madera
Madeira / Holz

2000/2600 mm
800 mm
H 774 h 455 mm

Disegni / Drawings / Plans / Dibujos / Desenhos / Zeichnungen/ p.: 683

Fissaggio: / Fixings: / Fixation: / Fijación: / Fixação: / Befestigung:
Predisposizione per tasselli - Cementazione
Pre-drilled for anchors - Below ground installation
Réserveation chevilles - Scellement
Predisposición para tacos - Cimentación
Preparação para buchas - Cimentação
Mit Bohrungen für Verschraubung - Zementierung



NO STANDARD CONFIGURATION

NO STANDARD CONFIGURATION

Antonio Citterio con Toan Nguyen
Sedis
benches





2007, ADI DESIGN INDEX™ AND "COMPASSO D'ORO



2008, XXI Edition of Premio Compasso D'Oro:
SEDIS bench (Design: Antonio Citterio with Toan Nguyen)

Antonio Citterio con Toan Nguyen

Sedis Sedis Torsion benches

209





VALENCIA

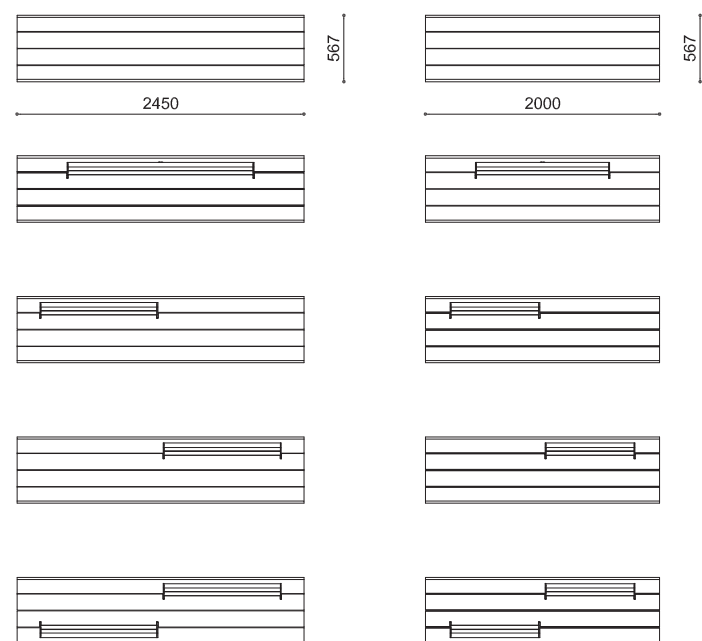
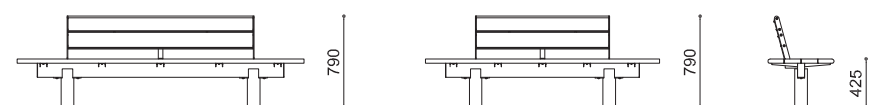

SCULPTURE

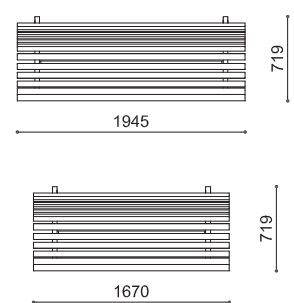
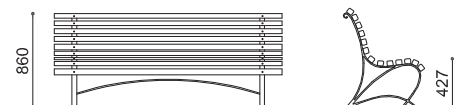

RIVA

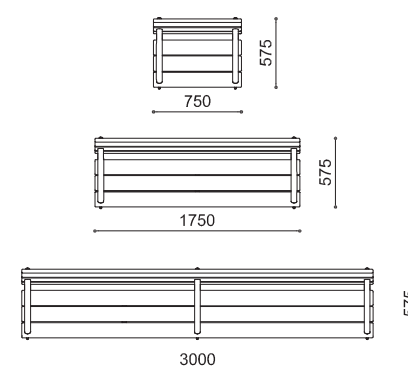
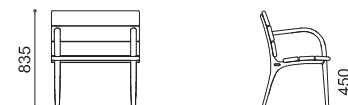

SEDIS

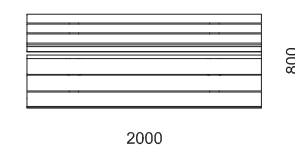
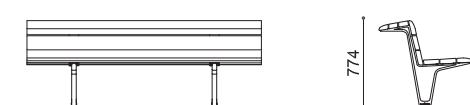

SEDIS TORSION

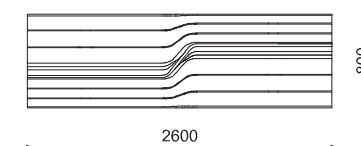
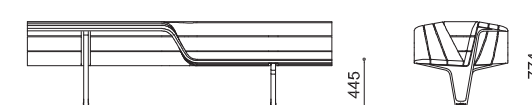

TOSO

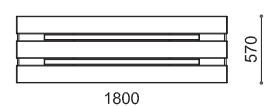

SLIDE

