

metalco

io sono differente l'm different



#03 OCTOBER 2015



CUSTOMISING FOR RECYCLING LITTER BINS

To customise the litter bins with written text and / or logo's on request, there are two options, both with its pros and cons

TYPE

- screen printing / pad printing
- adhesive labels

ADVANTAGES

- long term, difficult to vandalise
- lower cost, small quantities

DISADVANTAGES

- fixed costs
- limited resistance

PERSONALIZZAZIONE CESTINI PER RACCOLTA DIFFERENZIATA

Per personalizzare i cestini con scritte e/o loghi a richiesta, esistono due possibilità, con relativi pro e contro

TIPOLOGIA

- stampa serigrafica / tampografica
- applicazione di adesivi

VANTAGGI

- durata lunga, difficile vandalizzazione
- costi contenuti, piccole quantità

SVANTAGGI

- costi fissi
- resistenza limitata

Design is not
for philosophy
it's for life.

Issey Miyake

2	Aero
8	Ecomix
12	Ecoside
18	Bravo Boom
22	Mickey
26	C3
30	Marco Polo



Aero

Alfredo Tasca, Antonio Amendola, Elvira Cerrati, Raffaele Lazzari

Recycling bin for mixed waste, made of a steel frame covered by a sturdy steel shell. The aluminium lid is equipped with two gas struts to assist opening which are activated with the release of the snap lock. The 3 openings feed 3 internal steel liners for the introduction of differentiated waste, 6 feet add stability to the bin. Upon request the litter bin can be supplied with custom graphics.

Portarifiuti, per la raccolta differenziata composto da una struttura in acciaio rivestita da un robusto mantello. Coperchio in alluminio dotato di apertura con due martinetti a gas che si azionano con lo sblocco della serratura a scatto. Il cestone è dotato di 3 bocche per l'introduzione del rifiuto differenziato con relativi contenitori interni in lamiera e di 6 piedini per uno stabile appoggio a terra. A richiesta il cestone è fornibile con grafica personalizzata.



AERO 4

4 openings
4 bocche

3 openings
3 bocche

AERO 3

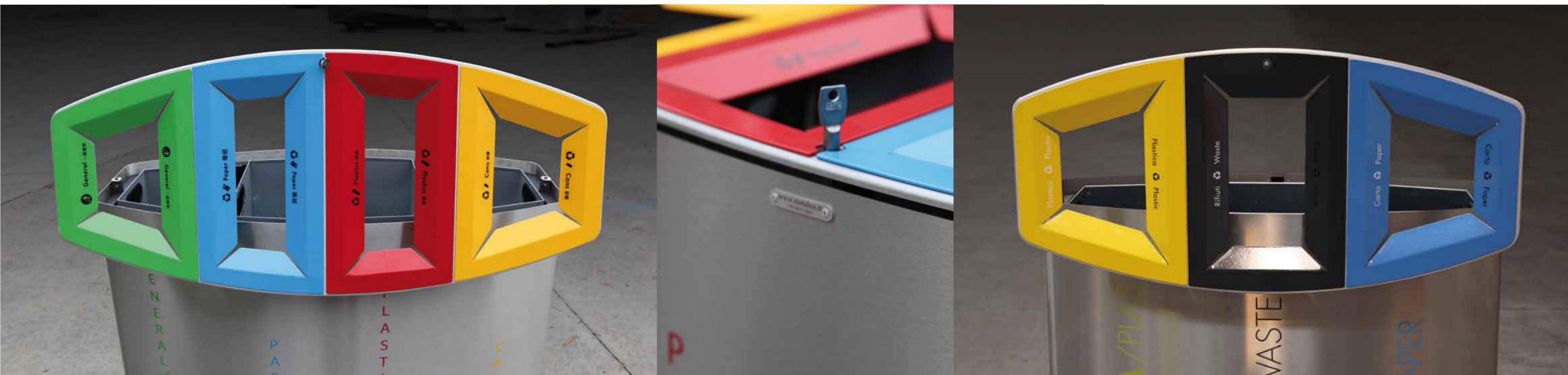

AERO, as you like it

Available in the following materials:
Galvanized and Powder Coated Steel
Stainless Steel

Fixings:
Free standing with pedestals

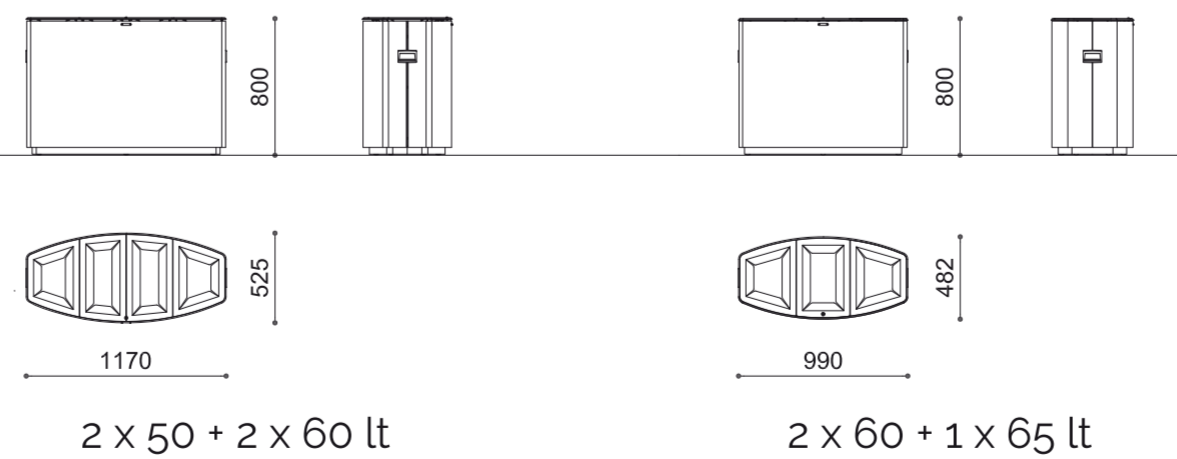

Disponibile nei seguenti materiali:
Acciaio Zincato e Verniciato
Acciaio Inox

Fissaggio:
Appoggio con piedini

AERO, come vuoi tu



Ecomix

Raffaele Lazzari

Litter bin, in a truncated pyramid shape, made in steel sheet with cast aluminium cover, which can be painted in four colours to facilitate the collection of different categories of recyclable waste, or in one single colour for standard use. The range is available with an ashtray fixed with antitheft steel cable.

Capiente portarifiuti di forma tronco piramidale in lamiera di acciaio con coperchio in fusione di alluminio, disponibile con verniciatura in quadricromia per la raccolta differenziata dei rifiuti urbani, o in unico colore per un uso indifferenziato dello stesso. La dotazione di serie prevede un posacenere con cavetto antifurto in acciaio.



ECOMIX, as you like it

Available in the following materials:
 Corten Steel
 Stainless Steel
 Galvanized and Powder Coated Steel

Fixings:
 Free standing, pre-drilled for anchors

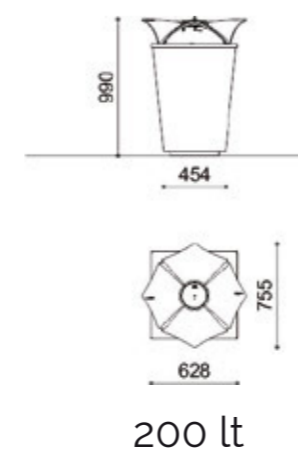

200 lt

Disponibile nei seguenti materiali:
 Acciaio Corten
 Acciaio Inox
 Acciaio Zincato e Verniciato

Fissaggio:
 Appoggio, predisposizione per tasselli

ECOMIX, come vuoi tu



Ecoside

Alfredo Tasca

Litter bin constructed on a steel frame with front hinged key opening flap with an easy closing snap lock. Available placed on the ground with steel plinth versions. Customizable with word stickers for recycling.

Cestino costituito da una struttura in acciaio con anta apribile a ribalta e chiusura a scatto. Disponibile nella versione in appoggio a terra con zoccolo in acciaio. Personalizzabile con scritte adesive, anche in serigrafia, per la raccolta differenziata.



ECOSIDE, as you like it

Available in the following materials
Galvanized and Coated Steel
Stainless Steel

Fixings:
Pre-drilled for anchors

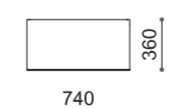
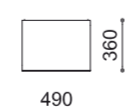
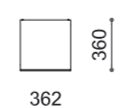
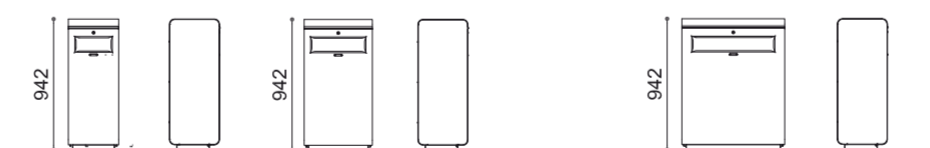

70 lt

100 lt

170 lt

Disponibile nei seguenti materiali:
Acciaio Zincato e Verniciato
Acciaio Inox

Fissaggio:
Predisposizione per tasselli

ECOSIDE, come vuoi tu



ECOSIDE 170 lt, with ashtray

ECOSIDE 170 lt, con posacenere



litter bin: 0025164
4 litter bins with base plate
and cover: 0025134



litter bin: 0025164
3 litter bins with base plate
and cover: 0025114



litter bin: 0025164
2 litter bins with base plate
and cover: 0025094



litter bin: 0025164
1 litter bin with base plate
and cover: 0025074



litter bin: 0025164
1 litter bin with
base plate: 0025064



litter bin: 0025164
2 litter bins with
base plate: 0025084



litter bin: 0025164
3 litter bins with
base plate: 0025104



litter bin: 0025164
4 litter bins with
base plate: 0025124

Bravo Boom

Mattia Li Pomi

Litter bin made of a simple cylindrical container made of a laser cut decorated steel sheet (this version is to allow visibility of the content). The litter bin is equipped with bag holding ring with snap closure. It can be supplied with a steel tube pole, supporting up to 3 baskets with/without cover, or with a bracket for mounting to a wall or to a pre-existing pole.

Cestino costituito da un semplice contenitore cilindrico in lamiera traforata in modo da rendere visibile il contenuto, completo di anello ferma sacco con chiusura a scatto. Il cestino è dotato di staffa per il fissaggio a parete o a palo esistente. Può essere anche fornito direttamente con relativo palo in tubo d'acciaio.

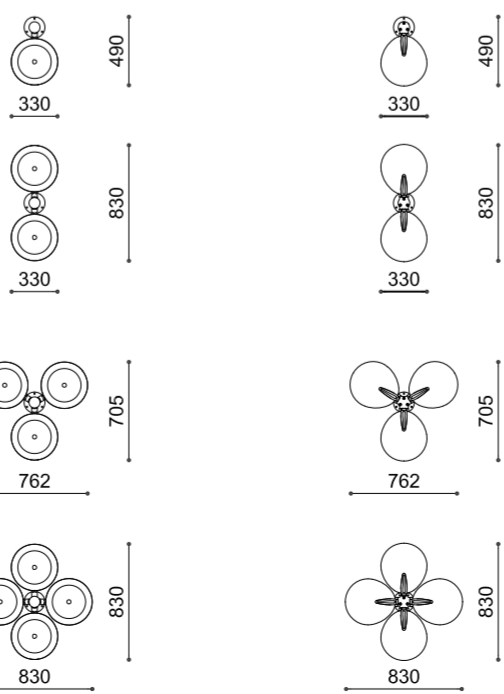
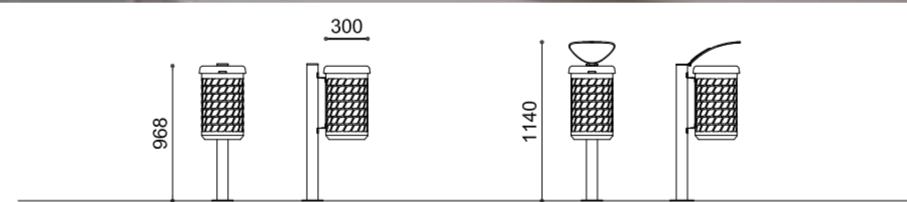

35 lt

BRAVO BOOM, as you like it

Available in the following materials:
Galvanized and Coated Steel

Fixings:
Pre-drilled for anchors (ground or wall)
below ground installation

Disponibile nei seguenti materiali:
Acciaio Zincato e Verniciato

Fissaggio:
predisposizione per tasselli (terra o parete)
cementazione

BRAVO BOOM, come vuoi tu



Mickey

Mattia Li Pomi

Recycling litter bin with cylindrical shape. The structure and the lid are made of satinized stainless steel. The opening is done through gas struts that are activated with the release of the lock. The litter bin is equipped with three openings for the introduction of the waste, internally tripartite by panels of steel sheet welded to a central tube support. Each section includes a movablering for bags fixing. Customizable both in structure with vertical writing, and on the lid coloring the edge of the openings.

Cestino per la raccolta differenziata di forma cilindrica con struttura e coperchio realizzati in acciaio inox satinato. Apertura mediante martinetti a gas che si azionano con lo sblocco della serratura a scatto. Il cestone è dotato di tre bocche per l'introduzione del rifiuto, tripartito internamente da pannelli in lamiera d'acciaio saldati ad un sostegno centrale in tubo. Ogni partizione prevede un anello mobile per il fissaggio dei sacchetti. Personalizzabile sia nella struttura con scritte verticali, che sul coperchio colorando il bordo dei fori d'entrata del rifiuto.



MICKEY, as you like it

Available in the following materials:
Galvanized and Coated Steel

Fixings:
Pre-drilled for anchors (ground or wall)
below ground installation

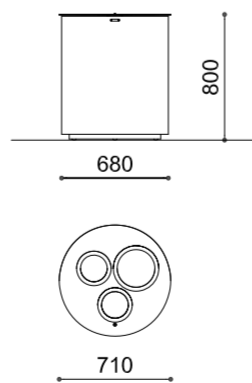

Disponibile nei seguenti materiali:
Acciaio Zincato e Verniciato

Fissaggio:
predisposizione per tasselli (terra o parete)
cementazione

MICKEY, come vuoi tu





C3

Alfredo Tasca

Set of modular litter bins for indoor, made of a cylindrical trunk, available in different heights with customized and colored lid, simply laid. They are in galvanized and powder coated steel and optional accessories are available if you want to attach one to the other.

Set di cestini modulari da interno, composti dal fusto cilindrico disponibile in diverse altezze e coperchio colorato e personalizzato in semplice appoggio. I cestini sono realizzati in acciaio verniciato e a richiesta sono disponibili accessori per il fissaggio tra loro.



C3, as you like it

Available in the following materials:
Galvanized and Coated Steel

Fixings:
Free standing



25 lt

34 lt

43 lt

Disponibile nei seguenti materiali:
Acciaio Zincato e Verniciato

Fissaggio:
Appoggio

C3, come vuoi tu



Marco Polo

Metalco Department

Litter bin designed for the categorised collection of rubbish divided internally in three segments by steel sheet panels, welded to a central tubular steel support. The strong external cylindrical structure, in perforated steel sheet, sits on a steel base plate. The cover is made from laser cut steel sheet and comes with three identifying apertures in three different colours, which can simply be lifted open to allow the removal of plastic waste sacks held by steel rings.

Portarifiuti realizzato per la raccolta differenziata dei rifiuti, tripartito internamente da pannelli in lamiera d'acciaio saldati ad un sostegno centrale in tubo. Robusta struttura esterna cilindrica in lamiera forata con base in piatto e coperchio apribile, realizzato da taglio laser di lamiera e dotato di tre fori identificati da tre colori diversi per l'introduzione separata dei rifiuti. Ogni partizione prevede un anello mobile per il fissaggio dei sacchetti.



MARCO POLO, as you like it

Available in the following materials:
Galvanized and Powder Coated Steel

Fixings:
Free standing, pre-drilled for anchors

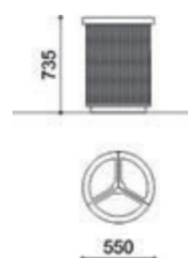

120 lt

Disponibile nei seguenti materiali:
Acciaio Zincato e Verniciato

Fissaggio:
Appoggio, predisposizione per tasselli

MARCO POLO, come vuoi tu



SOA OS24 cl. III - bis
OG9 cl. III - bis
OG10 cl. IV

Concept:
Marina Tasca

Foto - Photo:
Archivio Metalco / Metalco Archive
Marina Tasca
Studio Rocci
urnato.it

© Tutti i diritti riservati.
E' vietata la riproduzione anche parziale di immagini e testi.

© All rights reserved.
The reproduction of images, drawings and texts, even if partial, is forbidden.



The mark of
responsible forestry

Metalco
Via della Fornace, 44
31023 Castelminio di Resana (TV) Italy
Finito di stampare nel mese di Luglio 2015
Prima edizione
Printed in July 2015
Firt Edition

La Metalco Group Srl si riserva di apportare ai propri prodotti qualsiasi modifica ritenuta utile al miglioramento qualitativo degli stessi, sia dimensionale che strutturale.
Foto, disegni e testi non hanno carattere contrattuale.

Metalco Group Srl reserves the right to modify the dimensions and structure of its products at any time without prior notice in order to improve quality and durability.
Photos, drawings and texts are not contractual.

Per eventuali modifiche o aggiornamenti fare riferimento al sito web: metalco.it
For possible modifications or up dates, please refer to the web site: metalco.it



Tutti gli articoli ed i prodotti illustrati nel presente catalogo sono di proprietà esclusiva di Metalco Srl. Ogni contenuto ivi presente (modelli, testo, grafica, immagini, descrizione dei processi produttivi, logo, ecc.) è pertanto protetto ai sensi delle normative, anche internazionali, sui brevetti industriali e sui marchi registrati. E' autorizzata la riproduzione dei medesimi solamente con espressa indicazione della fonte, o comunque della proprietà dei medesimi. Nessun prodotto potrà, neppure in parte, essere copiato, contraffatto e/o immesso in commercio. Ogni eventuale violazione verrà perseguita e punita a norma di legge.

All items and products illustrated in this catalogue are the exclusive property of Metalco Srl. All content herein (models, text, graphics, images, description of production processes, logos, etc.) is protected by law, including international law, as industrial patents and registered trademarks. Reproduction of this is only authorised with express reference to the source, or particularly, ownership of the same. No product may, not even in part, be copied, forged and / or brought to market. Any violation will be prosecuted and punished by law.

metalco

metalco.it

HEADQUARTER

METALCO Srl

Via della Fornace, 44 - 31023

Castelminio di Resana (TV) ITALY

T +39 0423 78 63

F +39 0423 78 64 00

metalco.it

metalco@metalco.it

